











## B&W OUTDOOR.CASE TYPE 1000

Artikelnummer: 1000/Y

	zwei Ösen für Schlösser (Ø 4,5 mm)		staubdicht
	wasserdicht nach IP67		30 Jahre Garantie
	extrem robust		gummierter Tragegriff
	leicht zu öffnende Schlösser		stapelbar
	temperaturstabil		flugtauglich

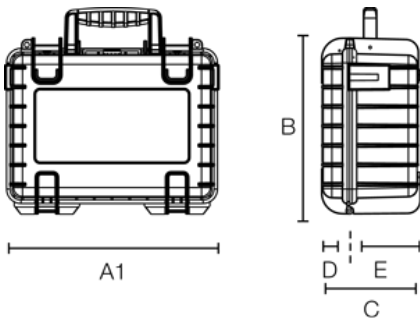

A (A1):	<b>270 mm</b>
B:	<b>215 mm</b>
C:	<b>105 mm</b>
A (A1) innen:	<b>250 mm</b>
B innen:	<b>175 mm</b>
C innen:	<b>95 mm</b>
D (Deckel) innen:	<b>25 mm</b>
E (Boden) innen:	<b>70 mm</b>

### Produkteigenschaften

Innenausstattung	leer vorgestanzter Würfelschaum (SI) variable Facheinteilung (RPD)
Zertifikate	UN 3090/91 UN 3480/81 ATA 300 MIL-STD-801G IP67 STANAG 4280 DEF STAN 81-41
Material	PP
Volumen (L)	4,1



B&W International GmbH | Junkendiek 5 | D-49479 Ibbenbüren  
Fon + 49 (0) 54 51 / 89 46-0 | Fax + 49 (0) 54 51 / 89 46-444 | info@b-w-international.com

[www.b-w-international.com](http://www.b-w-international.com)