











## B&W OUTDOOR.CASE TYPE 5000

Artikelnummer: 5000/Y

	zwei Ösen für Schlösser (Ø 7 mm)		staubdicht
	wasserdicht nach IP67		30 Jahre Garantie
	extrem robust		gummierter Tragegriff
	leicht zu öffnende Schlösser		stapelbar
	temperaturstabil		flugtauglich

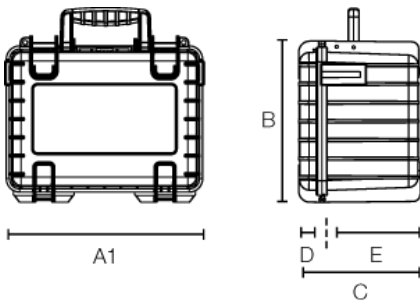

A (A1):	<b>470 mm</b>
B:	<b>365 mm</b>
C:	<b>190 mm</b>
A (A1) innen:	<b>430 mm</b>
B innen:	<b>300 mm</b>
C innen:	<b>170 mm</b>
D (Deckel) innen:	<b>45 mm</b>
E (Boden) innen:	<b>125 mm</b>

### Produkteigenschaften

Innenausstattung	leer vorgestanzter Würfelschaum (SI) variable Facheinteilung (RPD)
Zertifikate	UN 3090/91 UN 3480/81 ATA 300 MIL-STD-801G IP67 STANAG 4280 DEF STAN 81-41
Material	PP
Volumen (L)	22,1